

Digitilt Inclinometer Probe 50302599

Copyright ©2006 Slope Indicator Company. All Rights Reserved.

This equipment should be installed, maintained, and operated by technically qualified personnel. Any errors or omissions in data, or the interpretation of data, are not the responsibility of Slope Indicator Company. The information herein is subject to change without notification.

This document contains information that is proprietary to Slope Indicator company and is subject to return upon request. It is transmitted for the sole purpose of aiding the transaction of business between Slope Indicator Company and the recipient. All information, data, designs, and drawings contained herein are proprietary to and the property of Slope Indicator Company, and may not be reproduced or copied in any form, by photocopy or any other means, including disclosure to outside parties, directly or indirectly, without permission in writing from Slope Indicator Company.

SLOPE INDICATOR

12123 Harbour Reach Drive
Mukilteo, Washington, USA, 98275
Tel: 425-493-6200 Fax: 425-493-6250
E-mail: solutions@slope.com
Website: www.slopeindicator.com

Contents

Introduction	1
The Inclinometer Probe.....	2
Control Cable	4
Taking Readings.....	6
Data Reduction.....	8
Inspection and Maintenance.....	12

Introduction

- Inclinometer System** An inclinometer system includes inclinometer casing, an inclinometer probe and control cable, and an inclinometer readout unit.
- Inclinometer casing is typically installed in a near-vertical borehole that passes through a zone of suspected movement. The bottom of the casing is anchored in stable ground.
- The inclinometer probe is used to survey the casing and establish its initial position. Ground movement causes the casing to move away from its initial position. The rate, depth, and magnitude of this movement is calculated by comparing data from the initial survey to data from subsequent surveys.
- This Manual** This manual addresses the use and maintenance of the inclinometer probe and control cable. It also provides an overview of taking readings and reducing data.
- Other manuals cover casing installation, inclinometer readouts, and software for reducing data.

The Inclinometer Probe

Parts of the Probe

The inclinometer probe consists of a stainless steel body, a connector for control cable, and two pivoting wheel assemblies.

When properly connected to the control cable, the probe is waterproof and has been used deeper than 1000 feet.

The wheel assemblies consists of a yoke and two wheels. One of the wheels in each assembly is higher than the other. This wheel is called the “upper wheel” and has special significance, as explained below.

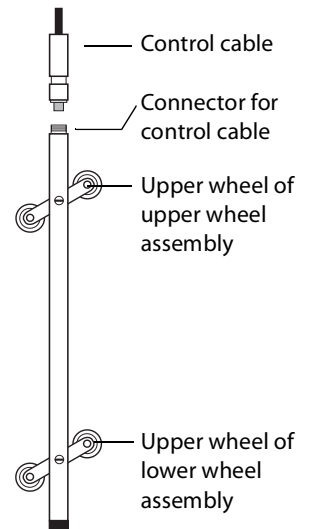

Measurement Planes

The inclinometer probe employs two force-balanced servo-accelerometers to measure tilt. One accelerometer measures tilt in the plane of the inclinometer wheels. This is the “A” axis. The other accelerometer measures tilt in the plane that is perpendicular to the wheels. This is the “B” axis.

The drawing at right shows the probe from the top. When the probe is tilted toward the A0 or B0 direction, readings are positive. When the probe is tilted in the A180 or B180 directions, readings are negative.

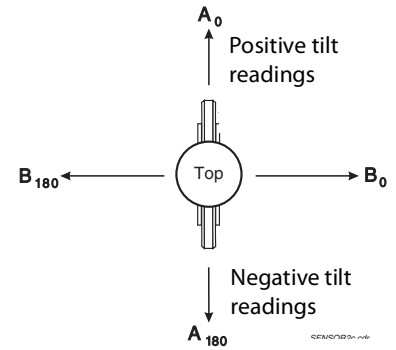

Orientation of the Probe

Inclinometer casing is installed so that one set of grooves is aligned with the expected direction of movement. One groove, typically the “downhill” groove should be marked A0.

In a standard inclinometer survey, the probe is drawn from the bottom to the top of the casing two times. In the first pass, the upper wheels of the probe should be inserted into the A0 groove. This ensures that movements are positive values.

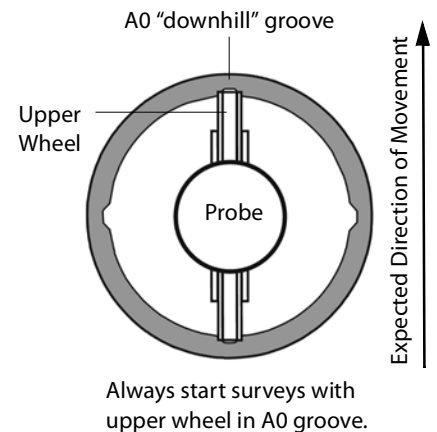

Handling the Probe

- The inclinometer probe is a sensitive measuring instrument. Handle it with care.
- Transport the probe in its carrying case. If you drive to the site, carry the casing in the passenger compartment, preferably on a passenger seat.
 - When you connect control cable to the probe, avoid overtightening the nut, since this will flatten the O-ring and reduce its effectiveness.
 - Before you lower the probe into the casing, turn the power on.
 - When you insert the probe into the casing, cup the wheels with your hands to compress the springs and allow smooth insertion.
 - When you lower the probe into the borehole, do not allow it to strike the bottom.
 - When you withdraw the probe from the casing, again cup the wheels with your hands to prevent them from snapping out.
 - When you rotate the probe, keep it upright and perform the rotation smoothly.
 - The probe is rated for temperatures from -20 to 50 °C (-4 to 122 °F). Avoid using the probe in temperatures outside this range.

Caring for the Probe

This is an overview. See the last chapter, Inspection and Maintenance, for additional information.

Cleaning the Probe: When you finish a survey, wipe moisture off the probe and replace the protective cap. If necessary, rinse the probe in clean water or wash it with a laboratory grade detergent when you return to the office.

Cleaning the Connectors: Do not clean connectors with spray lubricants or electrical contact cleaners. Solvents in these products will attack the neoprene inside the connector. When it is necessary to clean the connectors, use a cotton swab slightly moistened with alcohol. Be careful to use only a small amount of alcohol.

Drying the Probe: When you return to the office, remove protective caps from the control cable, probe, and readout unit. Allow connectors to air-dry thoroughly for a number of hours. Afterwards, replace the caps.

Storing the Probe: The probe, control cable, and readout unit should be stored in a dry place. For extended storage, keep the probe in a vertical position.

Lubricating the Wheels: Lubricate the wheels regularly. Spray a small amount of lubricant or place a drop of oil on both sides of the wheel bearings. Check that the wheels turn smoothly.

O-Ring Care: Periodically clean and lubricate the O-ring on the connector end of the inclinometer probe. Use O-ring lubricant.

Control Cable

Introduction

Control cable is used to control the depth of the inclinometer probe. It also conducts power to the probe and returns signals to the readout.

- Metric control cables are graduated with yellow marks at 0.5 meter intervals and red marks at 1-meter intervals. There are numeric marks at 5-meter intervals.
- English control cables are graduated with yellow markers at 2-foot intervals and red marks at 5-foot intervals. There are numeric marks at 50-foot intervals. In addition, there are yellow bands of tape at 10 foot intervals. Each band represents 10 feet from the last numeric mark. For example, 4 bands represent 40 feet from the last numeric depth mark.

Depth Control

Accurate inclinometer measurements depend on consistent placement of the inclinometer probe. Always align the depth marks on the control cable with the same reference. Aim for placement repeatability of 6 mm (1/4 inch) or better.

We recommend using a pulley assembly to assist with depth control. The jam cleat on the pulley assembly holds the cable and the top edge of the chassis provides a convenient reference for cable depth marks.

The small pulley assembly is used with 48 mm and 70 mm casing (1.9 and 2.75 inch). The large pulley assembly is used with 70 mm and 85 mm casing (2.75 and 3.34 inch).

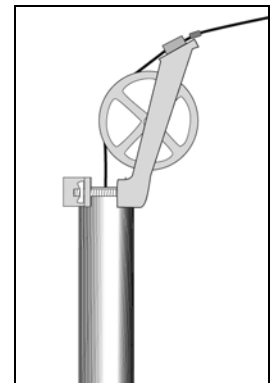

Using the Pulley Assembly

1. Remove the pulley from the chassis.
2. Clamp the chassis to the top of the casing.
3. Insert the inclinometer probe and control cable.
4. Replace the pulley.

Note: The distance between the top edge of the pulley chassis and the top of the casing is one foot. Your data reduction software can automatically adjust for this, so keep your survey procedure simple: use the marks on the cable and the top edge of the pulley chassis for reference. Let the software do any extra work required.

Check that operators consistently use the pulley assembly. If the pulley is used for one survey and not for the next, the resulting data sets will not be directly comparable. Sometimes a monument case or a protective pipe makes it impossible to attach the pulley assembly to the casing. In this case, you can make a removable adapter for the pulley assembly. If you use an adapter, be sure to use it consistently.

Cable Tips

Connecting Cable: When you connect control cable to the probe, avoid overtightening the nut, since this will flatten the O-ring and reduce its effectiveness.

Calibrate your Cable: If you have time, “calibrate” your cable, recording the exact position of cable marks. This can be important for long term monitoring projects.

Caring for Cable

Cleaning the cable: If necessary, rinse the cable in clean water or wash the cable in a laboratory-grade detergent, such as Liquinox.[®] Do not use solvents to clean the cable. Be sure the protective cap is in place before immersing the end of the cable in water. Do not immerse the Lemo connector.

Cleaning Connectors: If it is necessary to clean the connector, use a cotton swab moistened with a small amount of alcohol. Do not use spray lubricants or electric contact cleaners. Solvents contained in such products will attack the neoprene inserts in the connectors.

Drying Connectors: When you return to the office, remove protective caps from the control cable, probe, and readout unit. Allow connectors to air-dry well for a number of hours.

Storage: Store cable on a cable reel when possible. The reel should have a minimum hub diameter of 300 mm (12 inches). If a reel is not available, use the technique below to coil the cable.

Coiling Cable

1. Loop cable forward as shown in drawing.

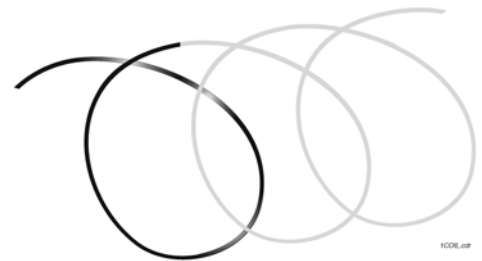

2. Twist cable backwards to make a second loop as shown in drawing.

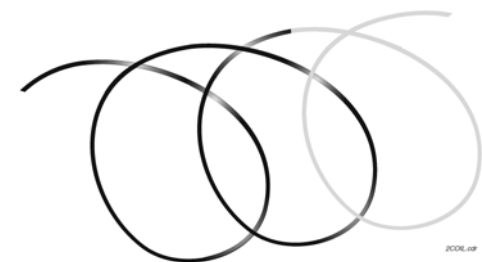

3. Continue coiling cable, alternating loops as in steps 1 and 2.

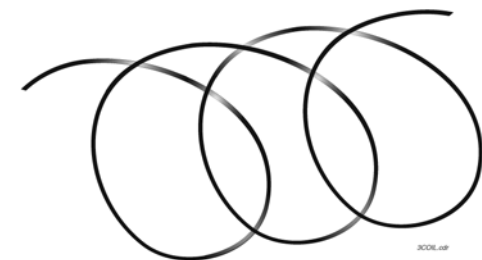

Taking Readings

Good Practices

- Use the same probe and control cable for each survey, if possible.
- Use a pulley assembly, if possible. It protects the control cable and provides a good reference.
- Use a consistent top reference. The goal is placement repeatability within 5 mm or 1/4 inch. If one technician uses a pulley and another technician does not, probe positioning will be inconsistent, and data will have to be manipulated before it is useful.
- Always draw the probe upward to the reading depth. If you accidentally draw the probe above the intended depth, lower the probe down to the previous depth, then draw it back up to the intended depth. This technique ensures the probe will be positioned consistently.
- Wait 10 minutes for the probe to adjust to the temperature of the borehole.
- Wait for displayed readings to stabilize as much as possible. If the readings do not stabilize, try to record an average reading.

Setting Up

1. When you arrive at the site, lay out a plastic sheet or tarp to set the equipment on. You should have the inclinometer probe, the indicator, the control cable, and the pulley assembly. Some people find it is useful to bring a basket or box to hold the control cable and a rag to wipe off the probe and cable after readings have been taken.
2. Unlock and remove the protective cap from the casing. Attach the pulley assembly.
3. Remove protective caps from probe and control cable.
4. Align the connector key with the keyway in the probe. Then insert the connector and tighten the nut to secure the connection. Do not over-tighten the nut, since this will flatten the O-ring and reduce its effectiveness.

Position the Probe

1. Turn on the indicator. This energizes the accelerometers, making them less susceptible to shock.
2. Insert the probe into the casing with the upper wheels of both wheel assemblies in the A0 groove. (Cup the wheels with your hands to compress the springs for a smooth insertion). If you are using the pulley assembly, take out the pulley wheel, insert the probe, and then replace the wheel.
3. Lower the probe slowly to the bottom. Do not allow it to strike the bottom. Allow the probe to adjust to the temperature inside the casing. Five or ten minutes is usually sufficient.

-
- Record Data**
1. Raise the probe to the starting depth. Wait for the numbers on the readout to stabilize. If you are using the DataMate, press the button to record both the A and B axis readings. If you are using a manual indicator, write down the A-axis reading, then switch to the B-axis and record that reading.
 2. Raise the probe to the next depth. Wait for a stable reading, and then record it. Repeat this process until the probe is at the top of the casing.
 3. Remove the probe and rotate it 180 degrees, so that the lower wheels of both wheel assemblies are inserted into the A0 groove. When you remove the probe, cup the wheels with your hands to prevent them from snapping outwards. Also, hold the probe upright when rotating it.
 4. Lower the probe to the bottom, raise it to the starting depth, and continue the survey. Take readings at each depth until you have reached the top. Remove the probe. At this point, you may want to validate the data set and make any corrections necessary.

Leaving the Site Wipe off the probe and cable. Replace end-caps on cable and probe and return the probe to its protective case. Replace the indicator's protective plugs. Coil the cable. Remove the pulley assembly and replace and lock the protective cap.

At the Office Wipe off the indicator and recharge its batteries. Transfer the data set to a PC. Oil the probe wheels. If the storage place is dry, remove protective caps from probe, indicator, and control cable to allow all connectors to dry.

Data Reduction

Inclinometer Measurements

The inclinometer probe measures tilt, rather than lateral movement. How does tilt provide information about lateral movement? The basic principle involves the sine function, an angle, and the hypotenuse of a right triangle. We are interested in the length of the side opposite the angle θ .

$$\sin \theta = \frac{\text{side opposite}}{\text{hypotenuse}}$$

$$\text{side opposite} = \text{hypotenuse} \times \sin \theta$$

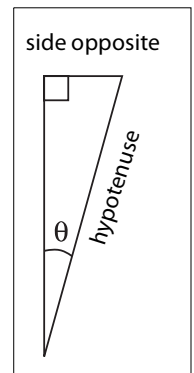

Deviation

In the drawing at right, the hypotenuse of the right triangle is the measurement interval. The measurement interval is typically 0.5 m with metric-unit inclinometers or 2 feet with English-unit inclinometers.

The side opposite the angle of tilt is deviation. It is calculated by multiplying the sine of the angle of tilt by the measurement interval. This calculation translates the angular measurement into a lateral distance and is the first step to calculating lateral movement.

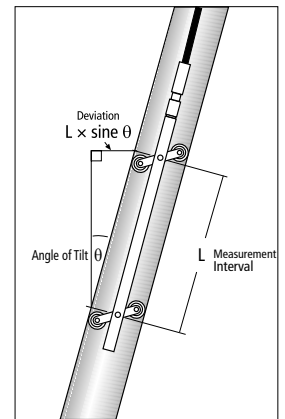

Cumulative Deviation

By summing and plotting the deviation values obtained at each measurement interval, we can see the profile of the casing.

The black squares at each measurement interval represent cumulative deviation values that would be plotted to show the profile of the casing.

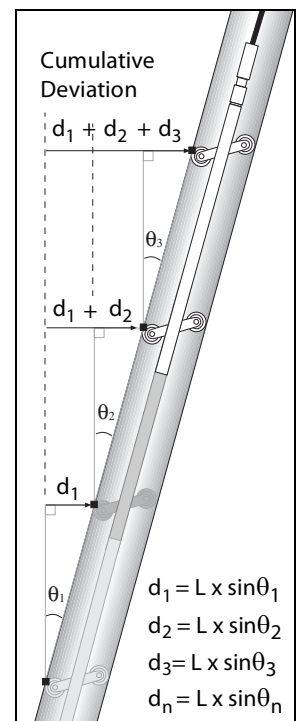

Displacements

Changes in deviation are called displacements, since the change indicates that the casing has moved away from its original position. When displacements are summed and plotted, the result is a high resolution representation of movement.

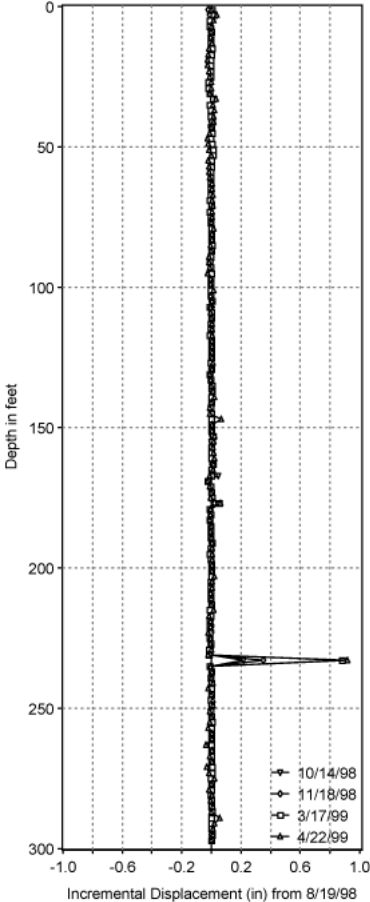

Incremental displacement plot shows movement at each measurement interval. The growing “spike indicates a shear movement.

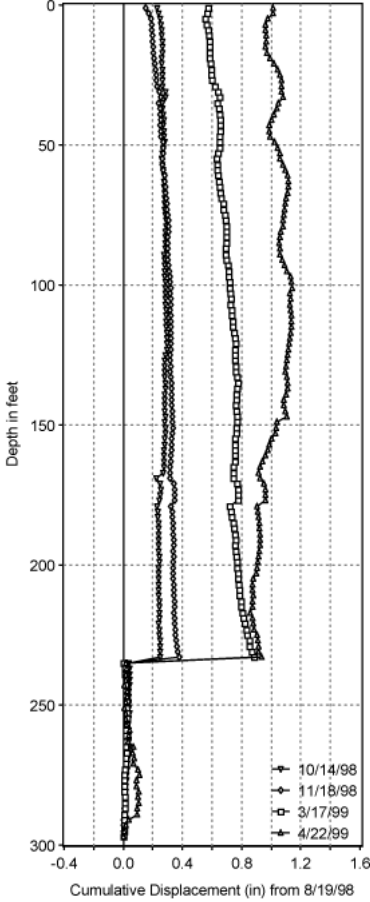

Cumulative displacement plot shows a displacement profile. Displacements are summed from bottom to top.

Reducing Data Manually

Normally, computer software is used to reduce inclinometer data. Here, we show only a simple overview.

Displayed Readings

Slope Indicator's readouts display "reading units" rather than angles or deviation. Reading units are defined below:

$$\text{Displayed Reading} = \sin \theta \times \text{Instrument Constant}$$

$$\text{Reading}_{\text{English}} = \sin \theta \times 20,000$$

$$\text{Reading}_{\text{Metric}} = \sin \theta \times 25,000$$

Combining Readings

The standard two-pass survey provides two readings per axis for each interval. The probe is oriented in the "0" direction for the first reading and in the "180" direction for the second reading. During data reduction, we find the algebraic difference of the two readings, and then we divide by 2, since there were two readings. Use of the algebraic difference lets us preserve the direction of the tilt, as indicated with a positive or negative sign.

$$A0 \text{ Reading} = 359 \quad A180 \text{ Reading} = -339$$

$$\text{Combined Reading} = \frac{359 - (-339)}{2} = 349$$

Calculating Deviation

To calculate lateral deviation, we find the algebraic difference of the two readings, divide by 2, divide by the instrument constant, and multiply by the measurement interval. In the example below, the English-unit measurement interval is 24 inches and the English-unit instrument constant is 20,000.

$$\text{Lateral Deviation} = \text{Measurement Interval} \times \sin \theta$$

$$\begin{aligned} &= 24 \text{ inches} \times \frac{359 - (-339)}{2 \times 20,000} \\ &= 0.4188 \text{ inches} \end{aligned}$$

Find the algebraic difference of the A0 & 180 readings and divide by 2.

Divide reading unit by instrument constant to obtain sine of angle.

Calculating Displacement

Displacement, the change in lateral deviation, indicates movement of the casing. To calculate displacement, we need two surveys. We subtract the initial combined reading from the current combined reading, divide by 2 x the instrument constant, and multiply by the length of the measurement interval.

$$\text{Combined Reading}_{\text{current}} = 700 \quad \text{Combined Reading}_{\text{initial}} = 698$$

$$\text{Displacement} = \text{Measurement Interval} \times \Delta \sin \theta$$

$$= 24 \text{ inches} \times \frac{700 - 698}{2 \times 20,000}$$

$$= 0.0012 \text{ inches}$$

Calculating Checksums

A checksum is the sum of a “0” reading and a “180” reading at the same depth.

$$A0 \text{ reading} = 359 \quad A180 \text{ reading} = -339$$

$$\text{Checksum} = 359 + (-339)$$

$$= 20$$

Bias (zero offset)

If you hold your inclinometer probe absolutely vertical and check the reading, you will typically see a non-zero value for each axis. The non-zero value is the result of a slight bias in the output of the accelerometers. The bias (or zero offset) may be negative or positive and will change over the life of the probe. This is not normally a matter for concern, because the zero offset is effectively eliminated by the standard two-pass survey and the data reduction procedure.

Below, we show an readings that have a zero offset of 10. During the first pass the probe measures a tilt of 1 degree. During the second pass the probe measures a tilt of -1 degree, because it has been rotated 180 degrees. See how the offset increases the positive reading and decreases the negative reading, even though the measured angle has not changed. However, when the two readings are combined, as discussed in “Combining Readings” above, the offset is eliminated and the correct value emerges.

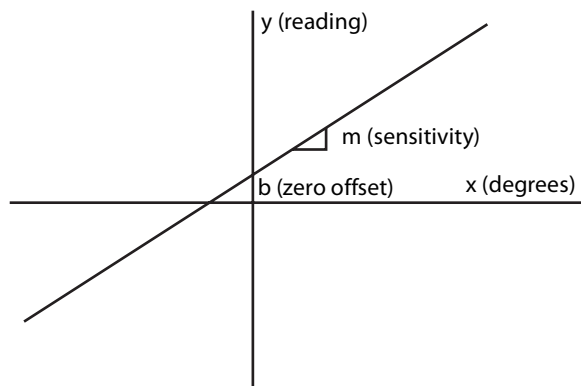

$$\text{Tilt angle} = 1 \text{ degree.} \quad \text{Theoretical reading unit} = 349 \quad (20,000 \times \sin(1))$$

$$\text{Offset} = 10$$

$$\text{Displayed A0 reading} = 359 \quad (349 + 10)$$

$$\text{Displayed A180 reading} = -339 \quad (-349 + 10)$$

$$\text{Combined reading} = 698 \quad (359 - (-339))$$

$$\text{Averaged reading} = 349$$

Inspection & Maintenance

Probe Inspection

Part	What to check for	Remedy
Wheel yoke	Side to side movement	Check pivot pin, which looks like screw. If pivot pin has been turned too far, it may spread the wheel yoke. Turn the pivot pin counter-clockwise to see if movement disappears. If movement persists, replace the nylon spacers or the entire wheel assembly. The wheel assembly can be replaced by the user: kit number 50302555.
Wheel yoke	Yoke does not return to fully extended position.	If yoke is dirty, clean it. If problem persists, spring may be broken or weak. Replace spring and roll pins or replace wheel assembly using kit 50302555.
Wheel	Side to side movement	Bad bearing. Replace wheel assembly.
Wheel	Does not turn freely	Lubricate. If movement is still bad, replace wheel assembly.
Body screws	Loose screws, wobble in body, loose bumper	Tighten screws. (Do not tighten pivot pin).
Connector keyways	Wear, corrosion	Worn keyway may degrade O-ring seal. Learn how to connect cable without "hunting." Remove corrosion and change practice - allow connector to dry after use.
Connector O-ring	Flattened, split	Replace if flattened or split.
Connector pins	Bent pins	Bent pins are easily broken when straightened. Replacement of connector requires recuperation of probe (expensive). Change connection practice - no hunting.

Probe Maintenance

Moisture Management	Wipe off the control cable and probe when you finish the day's final survey, then wipe off the probe. Do not store wet cloth with the probe. Allow the connector to dry thoroughly: remove connector cap and allow connector to air-dry for a number of hours. Lubricate the wheels. This helps displace moisture.
Wheels	Lubricate the wheels by spraying a small amount of lubricant or placing drops of oil on both sides of the wheel bearings.
O-Ring	Lubricate regularly with O-ring lube or silicone based grease. Do not use WD-40 or any other lubricant spray that contains chlorinated solvents.
Connectors	Clean connectors as necessary. Use a slim cotton swab moistened with alcohol. Be careful not to bend pins. Do not use electrical contact cleaners, especially sprays. Solvents in these products will attack the neoprene inside the connectors. When attacked, the neoprene swells and reduces the effectiveness of the O-ring seal.
Storage	Store probe in dry place. Be sure that the box is dry, the wheels are oiled, the connector is dry. If probe is to be stored for an extended period, stand it vertically.

Control Cable Inspection

Part	What to check for	Remedy
Cable	Continuity	If you have intermittent failures, perform continuity tests. If a wire fails continuity test, you can check the Lemo connector or return cable for servicing or replacement.
Cable	Twists, worn markings, kinks, gouges	Twists indicate poor coiling technique. Change practice: use cable reel, figure-8 coils, or over-under coils. Worn markings: user is dragging cable over the edge of the casing. Change practice - but must keep consistent depths. Kinks: if kinks do not straighten, there is probably internal damage and likelihood of intermittent reading failures. If any deep gouges, water can enter cable. In both cases, bad section of cable must be removed, either by shortening the cable or replacing the cable.
Connector key	Wear, corrosion	Change connection practice - no hunting. Remove corrosion and change practice - allow connector to dry after use.
Connector rubber insert	Swelling, poor seal	Rubber swells when attacked by WD-40 or contact cleaners. Swelling may prevent good seal and allow water to enter connector. Return for service if sealing is compromised.
Connector for Indicator (Lemo)	Corrosion, bad connection.	Perform continuity check first. Then check this connector to eliminate as possible source of intermittent failures. Unscrew bottom nut, being careful not to twist cable. Slide shell off the end of the cable. Slide strain relief collet out of the way and inspect connections. Twist and pull wires gently. Good connections will not break. Repair as necessary.
Connector for Probe	Check O-ring	Do <i>not</i> disassemble this connector. Requires about two hours and a pressure test to reassemble.

Control Cable Maintenance

Moisture Management	Wipe off the control cable as you draw the probe up on the last run of the day. When you return to the office, remove connector caps and allow connectors to air-dry for a number of hours.
Cable	When necessary, rinse cable (but not connectors) in clean water or wash the cable in a laboratory-grade detergent, such as Liquinox. Do not use solvents to clean the cable.
Connectors	If it is necessary to clean the connector, use a cotton swab moistened with alcohol. Sockets can be cleaned with a brush. Do not use spray lubricants or electric contact cleaners. Solvents contained in such products will attack the neoprene inserts in the connectors.
Storing Control Cable	Improper coiling of any electrical cable twists conductors and can cause reliability problems. There are several ways to control twisting: <ul style="list-style-type: none"> • Use cable reel with hub diameter of at least 200mm or 8". • Coil cable in a figure-8. • Coil cable using over-under loops (2-foot diameter loops).

Control Cable Connectors

Below is the wiring diagram for the connectors on the control cable.

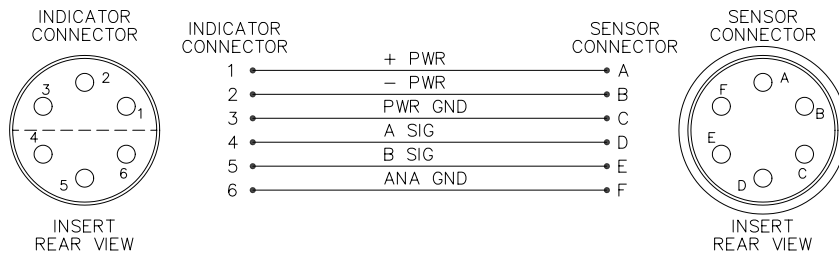

Testing Connectors are made to mate with each other but not with any other objects. Never insert the probe of your multimeter into a socket. In making the measurements below, simply touch the probe to the top of the socket.

Continuity Test: Pin 1 to Pin A, Pin 2 to Pin B, etc, should measure a little less than 1 ohm per 30 m (100 feet).

Isolation Test: Pin to pin should measure infinity. Also any pin to the body of the connector should measure infinity.

Servicing Use caution when attempting to service either connector.

The Lemo connector on the indicator end of the cable is easier to service. When you disassemble the connector, be sure that you do not twist the cables.

The heavy connector on the sensor (probe) end of the cable is more difficult to service. We recommend that you send it to the factory unless you are experienced and are willing to spend some time working with it.